



READ INSTRUCTIONS THOROUGHLY BEFORE OPERATING



TIRE SERVICE INTERNATIONAL

June 09, 2016

800.223.4540

3451 S. 40th St.  
Phoenix, AZ 85040  
602-437-5020













www.buytsi.com  
sales@buytsi.com  
Fax. 602-437-5025



## WARNING!

The instructions and warning contained in this manual should be read and understood before using or operating this tool. Do not allow anyone

to use or operate this tool until they have read this manual and have developed a thorough understanding of how this tool works. Failure to observe any of the following instructions could result in severe personal injury to tool user and bystanders, or cause damage to the tool and property. Keep this manual for future reference.

-  **WARNING** - Indicates a potentially hazardous situation which, if not avoided, could result in death or serious injury
-  **WARNING** - Personal Protective Equipment: Safety goggles, gloves, non-skid shoes and hearing protection.
-  **WARNING** - Keep bystanders and children out of the work area while operating this tool.
-  **WARNING** - Always keep work clean, uncluttered, and well lit. Do Not work on floor surfaces that are slippery.
-  **WARNING** - Do not operate this tool if you are tired or under the influence of alcohol, drugs, or medications that could affect your ability to use the tool properly.
-  **WARNING** - Air under pressure can cause severe injury. Never point an air tool at people or animals.
-  **WARNING** - Detach from air supply and release all air pressure before installing, removing or adjusting any accessory on this tool or performing maintenance. Failure to do so could result in injury.
-  **WARNING** - Do not open the Cheetah® Bead Seater air release valve when connecting the air supply hose. When the Cheetah® Bead Seater is not in use, discharge air from tank. Store with valve open in a clean, dry location. Never transport the Cheetah® Bead Seater with air in the tank.
-  **WARNING** - Do not tamper with the safety valve. Do not modify or alter the bead seater in any way.
-  **WARNING** - Inspect before each use. Do not use if broken, bent, cracked or damaged parts are noted (Including warning label). If the unit appears damaged in any way, is missing parts, or operates abnormally, it shall be removed from service immediately. All units that have been dropped, impacted suddenly, or dented should be removed from service.
-  **WARNING** - Only Cheetah® Bead Seating replacement parts should be used on the unit. Decals and parts are available through your Distributor or the manufacturer.
-  **WARNING** - The warnings, cautions and instructions discussed in this manual cannot cover all possible conditions and situations that may occur. It must be understood that common sense and caution are factors which cannot be built into this product, but must be applied by the operator.
-  **WARNING** - Operator should be familiar with all OSHA regulations (including 29 CFR 1910.177) pertaining to mounting, demounting and inflating all tires

### Label Description



Pressurized Device



Eye and Ear Protection



Read the Manual



TIRE SERVICE INTERNATIONAL

# CHEETAH BEAD SEATING TOOL INSTRUCTION MANUAL

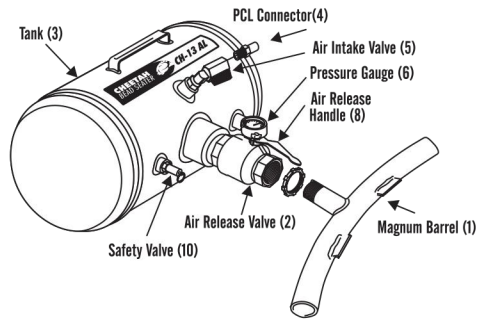

Figure 1 - Cheetah Bead Seating Tool - Major Components

## PREPARING THE CHEETAH FOR USE:

Check the Cheetah has arrived in good condition, with no signs of shipping damage, and that you can identify each of the parts named in figure 1. The Cheetah should arrive fully assembled except for the barrel (1) which must be fitted before use. To fit the barrel (1), thread it firmly onto the

Air Release Valve (2). Read the following instructions and safety information before use.

## GENERAL PRINCIPLE OF OPERATION OF THE CHEETAH:

Ordinary air supply lines for inflating tires do not deliver air quickly enough to expand a large or inflexible tire sufficiently to seal the tire bead onto the wheel rim. The Cheetah includes a tank (3) of compressed air which is delivered by a quick-acting Air Release Valve (2) and a large diameter barrel (1) into the tire. Because a larger volume of air is delivered very quickly, the tire bead is lifted onto the rim, creating an air tight seal and so allowing the tire to be inflated.

## FILLING THE CHEETAH

The Cheetah can be filled from any general commercial compressed air source. Refer to the Tank Pressure Information Table. Decide which Tire Type in the table most closely matches the tire you intend to inflate and identify the Suggested Tank Pressure. Ensure the Air Release Valve (2) is closed, attach the supply air line to the PCL connector (4) on the Cheetah then open the Air Intake Valve (5) to fill the Cheetah. When the Pressure Gauge (6) indicates the Suggested Tank Pressure has been reached, close the Air Intake Valve (5) and disconnect the supply air line.

## USING THE CHEETAH ON A HORIZONTAL TIRE AND WHEEL:

Place the wheel and tire flat on a tire stand so the lower side wall of the tire is slightly off the floor. Seat the lower tire bead on the bottom (narrow) flange of the wheel. Fit a supply air line to the tire valve to complete tire inflation after the bead is seated. Rotate the barrel (1) so the barrel Flange (7) is on top (i.e. the same side as the Air Release Handle (8) - as shown in figure 2). Hold the Cheetah at about 40° from the vertical and rest the barrel Flange (7) on the upper edge of the wheel rim opposite the tire valve and so that the barrel (1) is pointing into the opening between tire and rim. Check no-one is too close and warn others that you are about to release the air from the Cheetah. Hold the Cheetah Handle (9) firmly in one hand and with the other turn the Air Release Handle (8) to fully open in one movement, so releasing the air into the tire. When the bead has seated, use the supply air line to inflate the tire to its operating pressure.

## USING THE CHEETAH ON A VERTICAL/UPRIGHT TIRE AND WHEEL (EXTRA CARE NEEDED):

Use this vertical/upright method when there is a large gap between the wheel rim and tire bead or if the tire is particularly heavy.

**Safety Note:** the tire and wheel must be leaning slightly back and be secured by a wedge. **IMPORTANT!**

Support the wheel away from the wall so that the inflated tire will not be touching the wall. Otherwise, when inflating, the tire may push against the wall and cause the wheel and tire to fall forwards on top of the operator.

The back bead of the tire (furthest from the operator) should be seated against the wheel rim to trap the air. The front or wide flange of the wheel should be facing the operator. The valve stem should be at the bottom

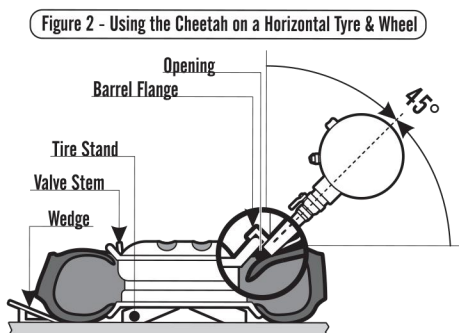
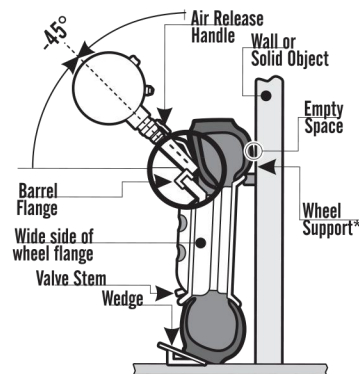

Figure 2 - Using the Cheetah on a Horizontal Tyre & Wheel

of the tire. Fit a supply air line to the tire valve to complete tire inflation after the bead is seated. Rotate the barrel (1) so the barrel Flange (7) is underneath (i.e. the opposite side from the Air Release Handle (8) - as shown in figure 3). Hold the Cheetah at about 40° from the horizontal and locate the barrel Flange (7) against the edge of the wheel rim near the top of the wheel, and opposite the valve stem, so that the barrel (1) is pointing into the opening between tire and rim. Check no-one is too close and warn others that you are about to release the air from the Cheetah. Hold the Cheetah Handle (9) firmly in one hand and with the other hand turn the Air Release Handle (8) to fully open in one movement, so releasing the air into the tire.

Figure 3.- Using the Cheetah in an Upright Position



## HELPFUL HINTS

### PRESSURE

The pressures listed in the Tank Pressure Information Table can be used as a starting point and then adjusted up or down as necessary. Adjust the pressure **downwards** if, when the Cheetah is applied, the tire bead appears to seat at first and then falls off again (this happens because too much air in the Cheetah has pushed the tire back off the rim after it has seated). Adjust the pressure **upwards** if the Cheetah does not lift the tire bead far enough.

### LUBRICATE

Lubricate all tire beads properly before using the Cheetah. It can seem the Cheetah is failing as it lifts the bead or the bead can fall off once seated. This may be due to poor bead lubrication.

### ANGLE TO APPLY CHEETAH BARREL (1)

The angle at which the Cheetah is applied is important. Too steep, and the air will hit the outside of the tire, and push it away from the rim. Too shallow and the air hits the rim and does not go into the tire. Angle the Cheetah so that the barrel (1) points directly into the gap between the tire and rim.

### WHERE TO APPLY CHEETAH

The most effective position to apply the Cheetah is opposite the tire valve. This results in both sides of the tire receiving an air supply. Another factor is the size of the gap between wheel rim and tire bead. The Cheetah should be applied at the place where the gap is largest. This ensures that the maximum amount of air enters the tire, creating the maximum lift, in the area with the worst problem. If a wedge has been properly used, the largest gap should be opposite the valve.

### USE OF A WEDGE

A wedge, such as included in the Cheetah Accessory Pack is used to ensure that the air from the supply line going into the valve is not wasted directly in to the air. Position the wedge under the tire close to the valve stem (figures 2 & 3). Try to position the tire to cover the valve.

### AIR LINE SAFETY

The air line supplied with the Cheetah Accessory Pack is designed to deliver the maximum volume of air and let the operator have both hands free to operate the Cheetah. The air line supplied with the Cheetah Accessory Pack must only be used for the initial seating of the bead. **Do not use the air line supplied with the Cheetah Accessory Pack for the inflation of tires beyond 12 psi (0.8 bar).**

### OPERATING THE AIR RELEASE HANDLE (8)

The Air Release Handle (8) should be turned quickly and fully in one movement.

### STORAGE

The Cheetah should be stored by hanging by the handle with the valve open. This allows any moisture to drain from the tank when the Cheetah is not in use. It also protects the barrel (1) and other attachments on the Cheetah from damage.

The Cheetah® uses compressed air. Please ensure that it is only used for the purpose for which it was designed. The following safety procedures must be observed. Ensure that the Cheetah® is only charged immediately before use. **NEVER STORE OR TRANSPORT A CHARGED TANK!**

### CONSTRUCTION

The barrel is threaded on to the air intake valve to allow for rotation. Check when operating the Cheetah® the barrel is orientated in accordance with the manual and the barrel has been tightened. Note that the pressure gauge accuracy is +/- 10%.

### AIR SUPPLY

The Cheetah® is a high quality tool, approved to CE and ASME standards. It has been tested by the manufacturer to 120 PSI and has a pressure release valve which will not allow it to exceed that pressure. The Cheetah® must be charged from a clean, oil-free, dry air supply and should only be charged from a low pressure airline system (up to 120 PSI). The Cheetah® should never be filled with anything other than air at ambient temperature.

### HEARING PROTECTION

Ear defenders must be worn at all times when discharging the Cheetah®. The Cheetah® produces high level noise which can seriously damage hearing. The recommended defenders are: Foamed polymer ear plugs. Consideration must also be given to people working close to the Cheetah®.

Noise Specification (Assuming the Cheetah® is used, on average, 6 to 10 times per day):

Average Equivalent Noise Level (L/AEq) < 70 dB.  
Peak C Weighted Instantaneous Sound Pressure = 135 dB = 112.46 Pa.

(Measurements were taken discharging the Cheetah into free air. The noise level is reduced when discharged at a tire and rim.)

### EYE PROTECTION

Eye protection must be worn whenever the Cheetah® is discharged. Dust, swarf, rust and other particles may be blown back into the user's eyes. Recommended goggles are polycarbonate safety goggles to BS 2092 grade I standard.

### TIRES - EXPLOSION RISK

Before using the Cheetah® on a tire or inflating any tire consider:

- Tire Damage - Inspect the tire for damage. Do not inflate damaged tires.
- Split Rims - Ensure that any locking ring is firmly in place.
- Inflation - Do not over inflate the tire.

Use a safety cage for inflating large tires or tires at high pressures.

### OTHER USES

Under no circumstances use the Cheetah® for any purpose other than that for which it was designed.

In particular:

- **Do not store or transport a charged tank.**
- **Do not** use it for dusting down equipment or people.
- **Do not** discharge the Cheetah® towards anyone.
- **Do not** clean a tire with a flammable solvent before using the Cheetah®.
- **Do not** subject the tank to any stress or impact that might weaken it.

### DRAINING

Ensure the Cheetah® tank is drained regularly. This is best done by hanging up with the Air Release Handle (8) open and the barrel (1) pointing down.



### TIRE STAND

A tire stand designed to hold the wheel and tire in the best position for applying the Cheetah is also available.



### TIRE WEDGE

The tire wedge is used to support the tire to maximize bead contact with the rim. Place the wedge under the side of the tire near to the valve. This ensures that air entering through the valve goes into the tire, and does not escape straight away.



### AIR HOSE

This is a ball-valve operated airline which enables the fitter to operate the airline connected to the tire valve stem easily while handling the Cheetah. Improves the safety of the product as the operator is in full control of the air supply.

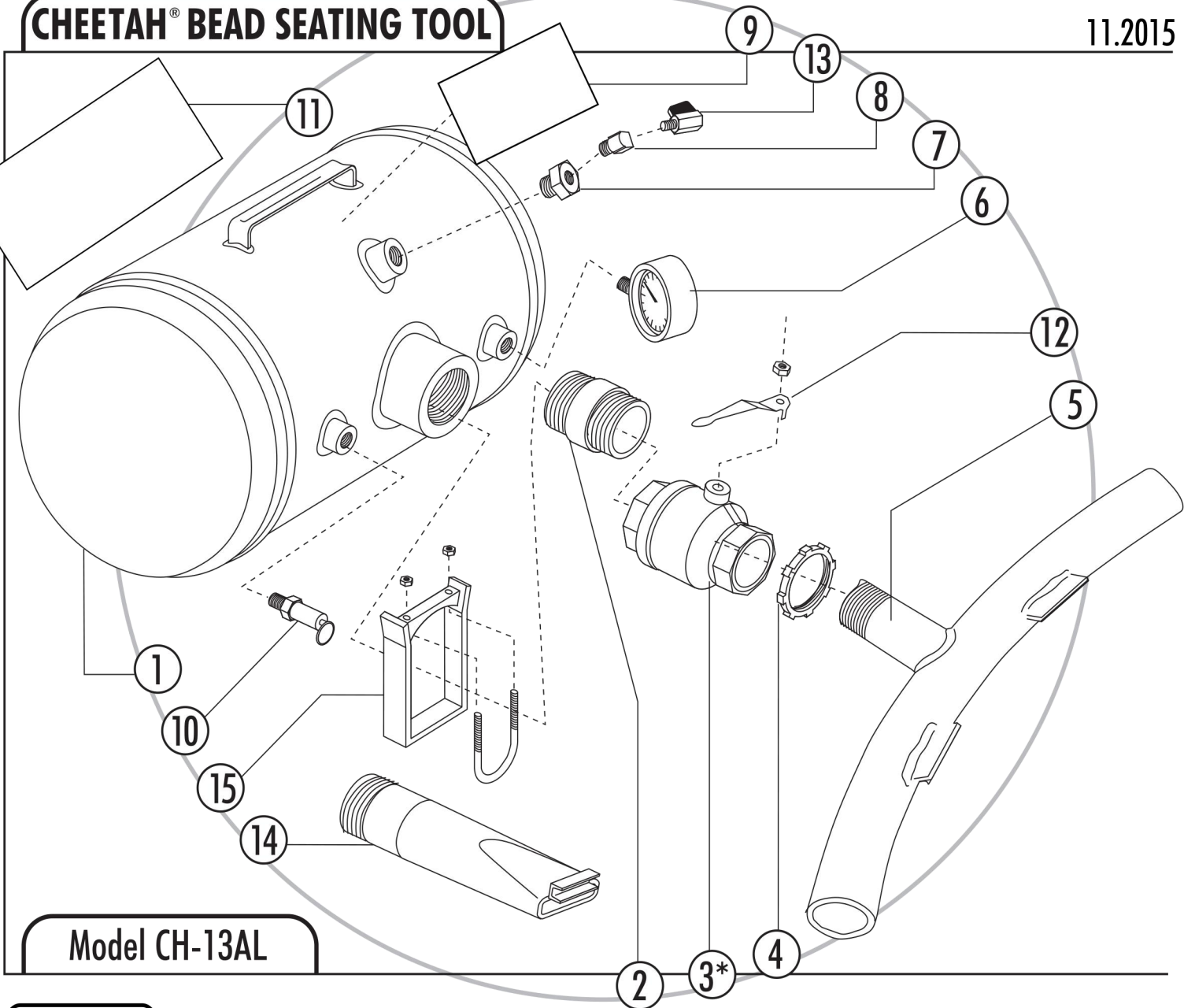

Model CH-13AL

### Repair Parts

No.	Description	Part No.	No.	Description	Part No.
1.	Airtank	N/A	10.	Safety Release Valve	05.102
2.	Pipe Nipple	02.104	11.	Decal (Large)	01.112
3.*	Discharge Valve	03.102	12.	Handle & Nut Only (Specify Color)	01.230
4.	Lock Nut	03.107	13.	Ball Valve	04.103
5.	Magnum II Barrel	03.106	14.	Threaded Barrel	03.103
6.	200 PSI Gauge	01.106	15.	Support Handle	05.107
7.	3/4" - 1/4" Bushing	01.107			
8.	90° NPT	03.104			
9.	Decal (small)	01.113			

\*Includes Handle

**Order parts from your distributor or jobber.** When ordering parts always give the following information: Part Number, Description and Serial Number of Your Machine.

**PCL CONNECTER is not INCLUDED must be purchased separately.**

**REMINDER: Always exercise caution when using compressed air.**



TIRE SERVICE INTERNATIONAL

# Warranty Statement & Return Policy

Warranty & Workmanship you can depend on.

With over 25 years of manufacturing experience we maintain the ability to provide competitive prices while employing and manufacturing the majority of our products in the USA. Pride in our workmanship and standing behind each and every product is not just our claim but our uncompromising responsibility.

TSISSG equipment is warranted to be free from defects in materials and workmanship for a period of one year from the date of original purchase to the original owner. Repair labor is warranted for 90 days from the date of original purchase. Bushings, blades, bearings and normal wear and tear are not covered under warranty. Careless handling, negligence, misuse, abuse, mutilation, improper operation, making unauthorized repairs, additions, and or alterations automatically cancel this warranty and relieves TSISSG of any obligation. Cheetah tanks claimed to be defective while under warranty will be evaluated at our manufacturing plant and either repaired if possible or exchanged and returned or credit issued to the customer account at our discretion. Damage resulting from dropping the tanks will not receive warranty consideration. Warranty parts need to be returned prepaid to the plant for credit. Any replacement parts shipped from the plant will be shipped at the customer's expense. Machines requiring warranty work must be brought to the manufacturing plant in 201 Chelsea Rd, Monticello, MN or to a repair facility authorized by TSISSG.

## Return Policy:

***!!WARNING!! Goods returned without an RGA will be refused. A Returned Goods Authorization form must be obtained before returning any material or goods. All non-warranty returns will be subject to a 15% restocking fee plus any additional charges for reconditioning/repacking.***



TIRE SERVICE INTERNATIONAL

