



TIRE SERVICE INTERNATIONAL

TC-300 Wheel Crusher

buyTSI.com - 800.223.4540



Read this manual before operating

Tire Service International, LLC

3451 S. 40TH ST.
Phoenix, AZ 85040

Office: 602.437.5020
Email: sales@buytsi.com
Fax: 602.437.5025

Contact us for any assistance

800.223.4540

Revised: March 2024

Safety Requirements

1. Only personnel trained in the operation of the TC-300 should be operating this machine.
2. Thoroughly read all safety and operating instructions before using this machine.
3. NEVER wet engine, motor, switch box or hydraulic controls. Cover these items if the machine is to be washed. Always disconnect electrical power before attempting maintenance. Gasoline or Diesel engines-please refer to the specified engine manuals supplied by these companies.
4. Caution: Motor rotation must be clockwise when looking at the end of motor. If electric motor runs counter-clockwise. reverse the wires as indicated on the motor plate diagram

Installation Requirements

Electrical Installation: The TC-300 Electric requires a minimum of 50 AMP, 230 volt, 60 cycle at the machine. The TC-300 Electric is equipped with a 10 HP, 230/460 volt, 60 cycle standard.

Set-Up Instruction



Position TC-300 near tire and wheel supply to be crushed. Place front support jack in position. Crank jack to bring TC-300 main beam to approximate level position.

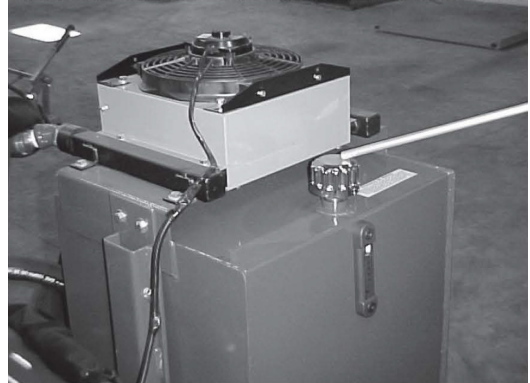

Check to be sure breather is installed in top of hydraulic reservoir.

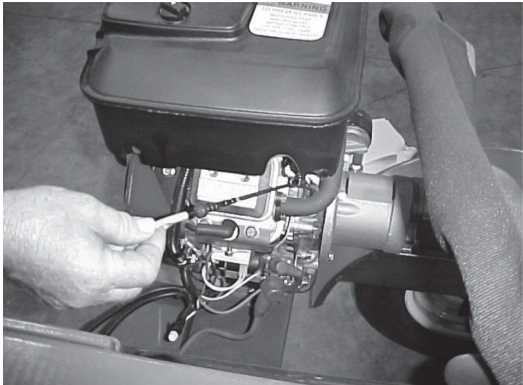

Check engine for oil and fuel levels. Turn on fuel valve, start engine using manufacturers operating instructions.

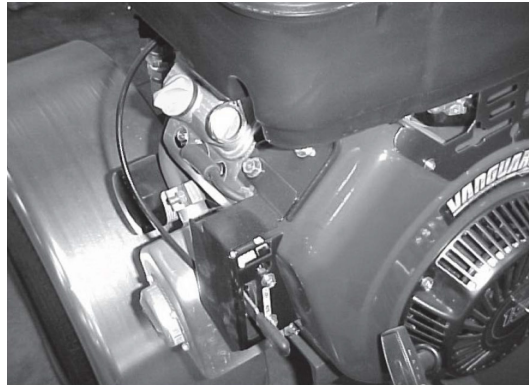

When crushing wheels, run engine at 3/4 open throttle.



Place tire & wheel into the TC-300 crushing chamber. Place wheel with valve stem facing up. Center wheel over beam. NOTE: It is recommended that air be vented from tire.

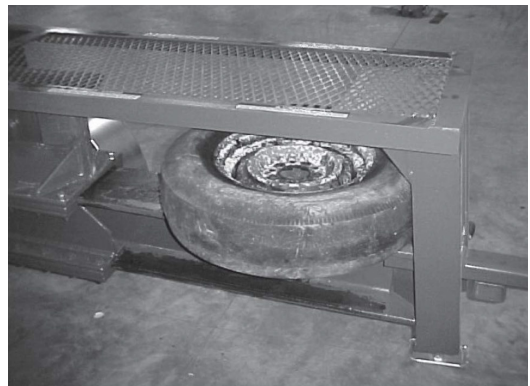

Position tire to the front against the crushing frame as shown.

Operating Instructions

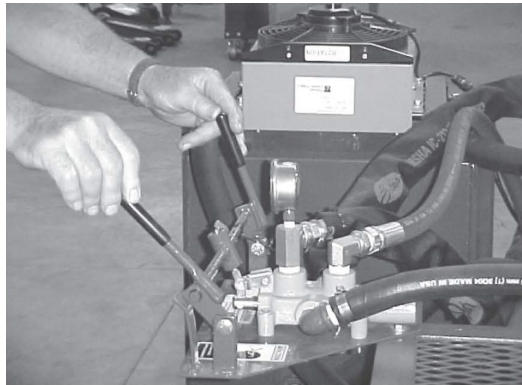

Operate Hydraulic valve handles. Pull valve handles towards operator to crush wheel. Push valve handles away from operator to return crushing wedge to starting position.

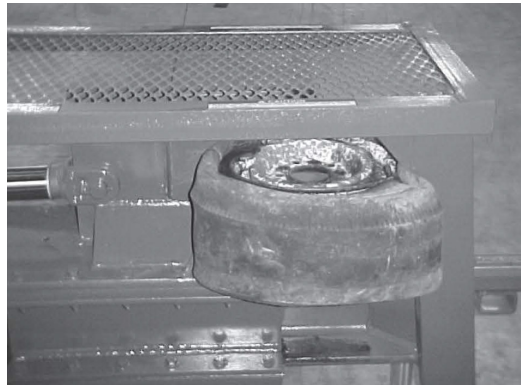

This photo illustrates the wheel being partially crushed.

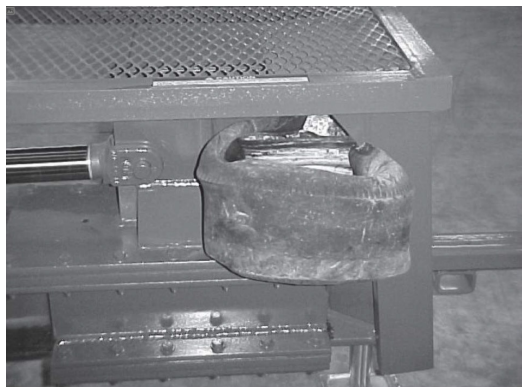

This photo illustrates the wheel being fully crushed.

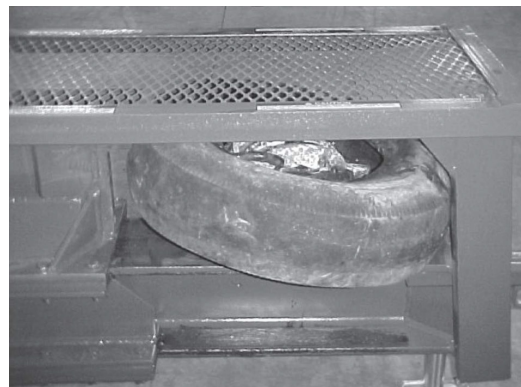

Operate hydraulic valve handles to return crushing wedge to the starting position.



Slide the wheel and tire out of the TC-300 chamber. NOTE: The wheel and tire can be taken out of either side of the machine



This photo illustrates the wheel crushed and separated from the tire.

Operating Instructions - Light Truck Tires

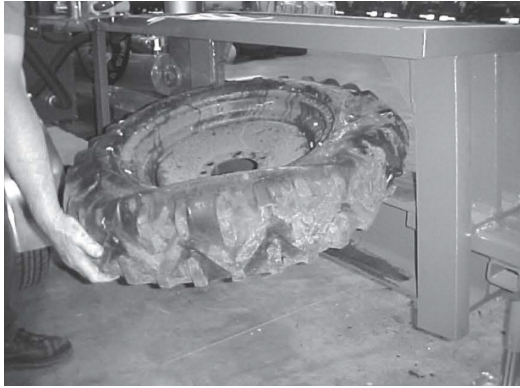

Place tire & wheel into the TC-300 crushing chamber. Place wheel with valve stem facing up. Center wheel over beam. NOTE: It is recommended that air be vented from tire.



Position tire to the front against the crushing frame as shown.

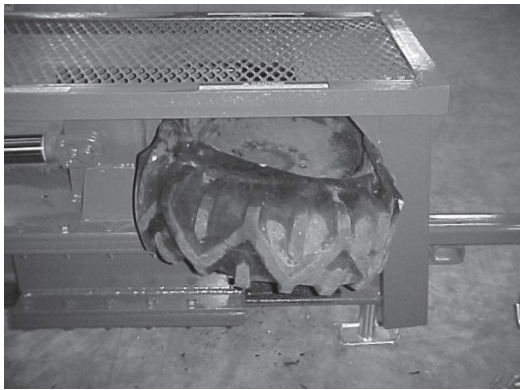

This photo illustrates the wheel being fully crushed.



Operate hydraulic valve handles to return crushing wedge to the starting position.



Slide the wheel and tire out of the TC-300 chamber. NOTE: The wheel & tire can be taken out of either side of the machine
NOTE: If the light truck wheel is a lock ring style always place lock ring down against the beam



This photo illustrates the wheel crushed and separated from the tire.

Maintenance

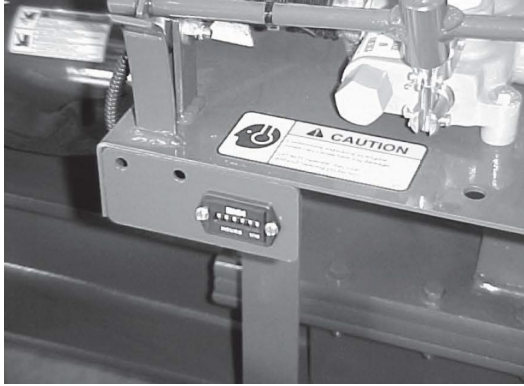

The Hour Meter indicates elapsed hours for proper engine maintenance service intervals.

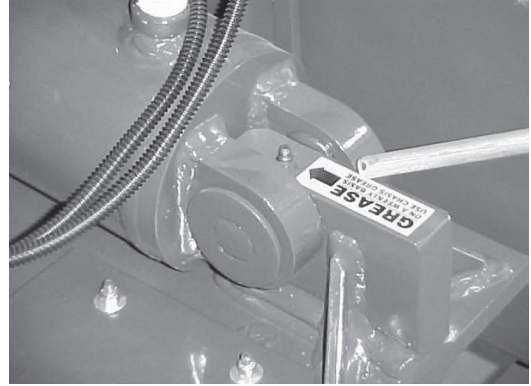

Periodically insert grease at the cylinder pivot.

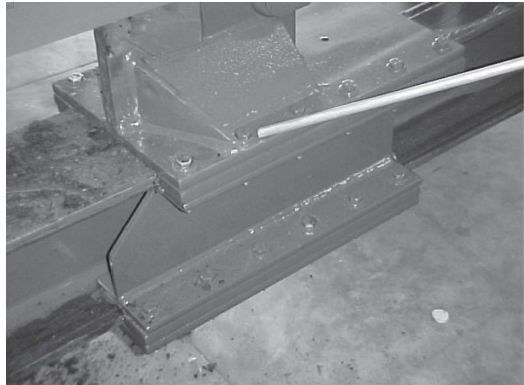

Before daily operation check all bolts for tightness on the movable wedge.

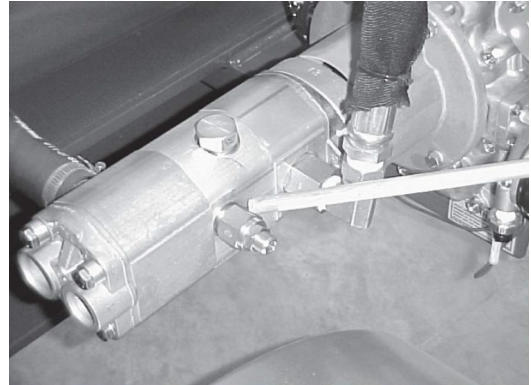

This adjustment controls low to high pressure shift point. If motor bogs down-loosen lock nut and turn Allen screw counter clockwise 1 / 2 turn and retry



Once every 6 months, remove wheels & hubs from axle and pack the wheel bearings with a wheel bearing grease.

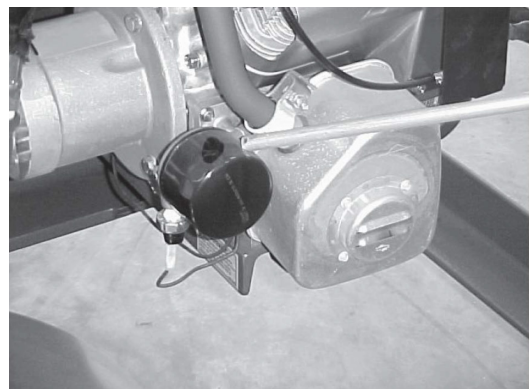

This photo illustrates the Oil filter location on the engine. Replace filter every 6 months for smooth engine operation

NOTE: Review Engine Manufacturer's manual for more info on servicing engines

Maintenance

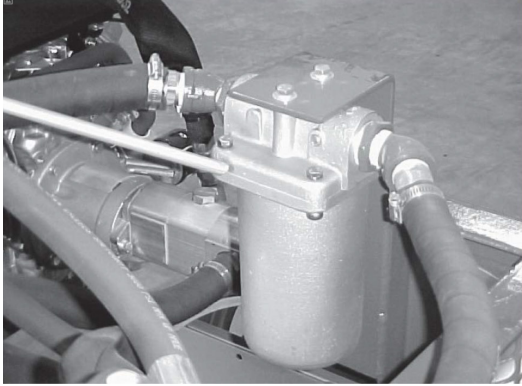

Replace oil filter every 6 months. Use TSI P/N 10130E for the replacement element

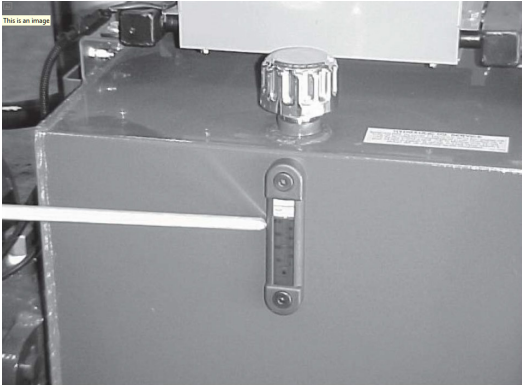

Check hydraulic oil reservoir level by viewing the sight glass. Oil level should be approximately 3" -5" from the top.

NOTE: HYDRAULIC FLUID SHOULD BE DRAINED AND REFILLED EVERY 6 MONTHS. USE UNIVERSAL AUTOMATIC TRANSMISSION FLUID-SAE 20 OR SAE 30

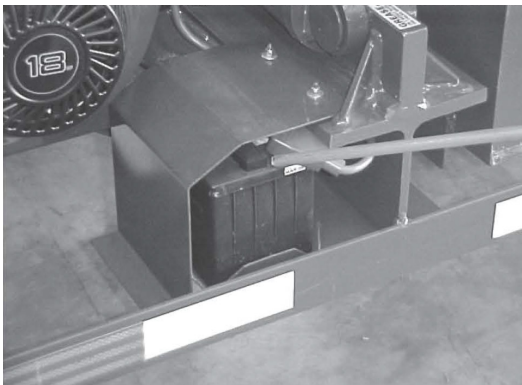

Every 6 months check battery condition

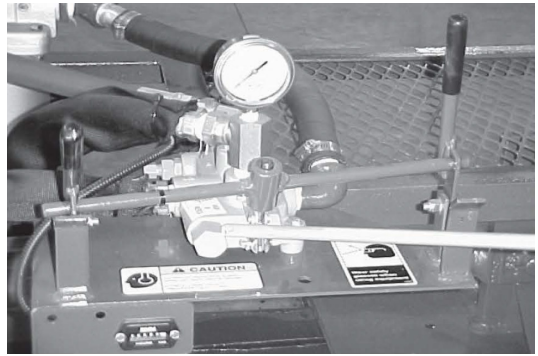

This photo illustrates the adjustment location of the hydraulic pump pressure to the valve. The gauge should read 2800-3000 PSI when the ram is fully extended. To increase pressure, first remove large Hex nut. Then using a Hex Allen wrench-turn adjustment screw to the right 1/4 turn at a time & recheck until pressure is 2800-3000 PSI.

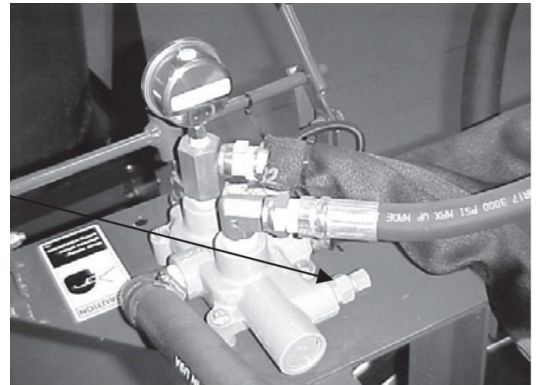

If the valve "kicks out" on the arms return stroke, the detent will have to be tightened slightly. Loosen lock nut as shown. Tighten outer nut 1/4 turn and tighten lock nut. Continue to crush. If it "kicks out" again, readjust it another 1 / 4 turn.

Maintenance



The crushing wedge has space wear bars on both the upper and lower slides. These wear bars may need adjusting. Loosen 6 upper and 6 lower cap screws and slide wear bars up to beam flange. Leave 1/32 clearance between beam and wear bar. If wear bars are worn too much, remove bars and turn side to side. This will give a new side to guide on. **DO NOT ALLOW SLIDE BOLTS TO LOOSEN. KEEP BOLTS TIGHT TO 100 FT-LBS & ADJUST SLIDE PLATES IF NECESSARY.**

Notes

Optional - Roller Table Kit #6114

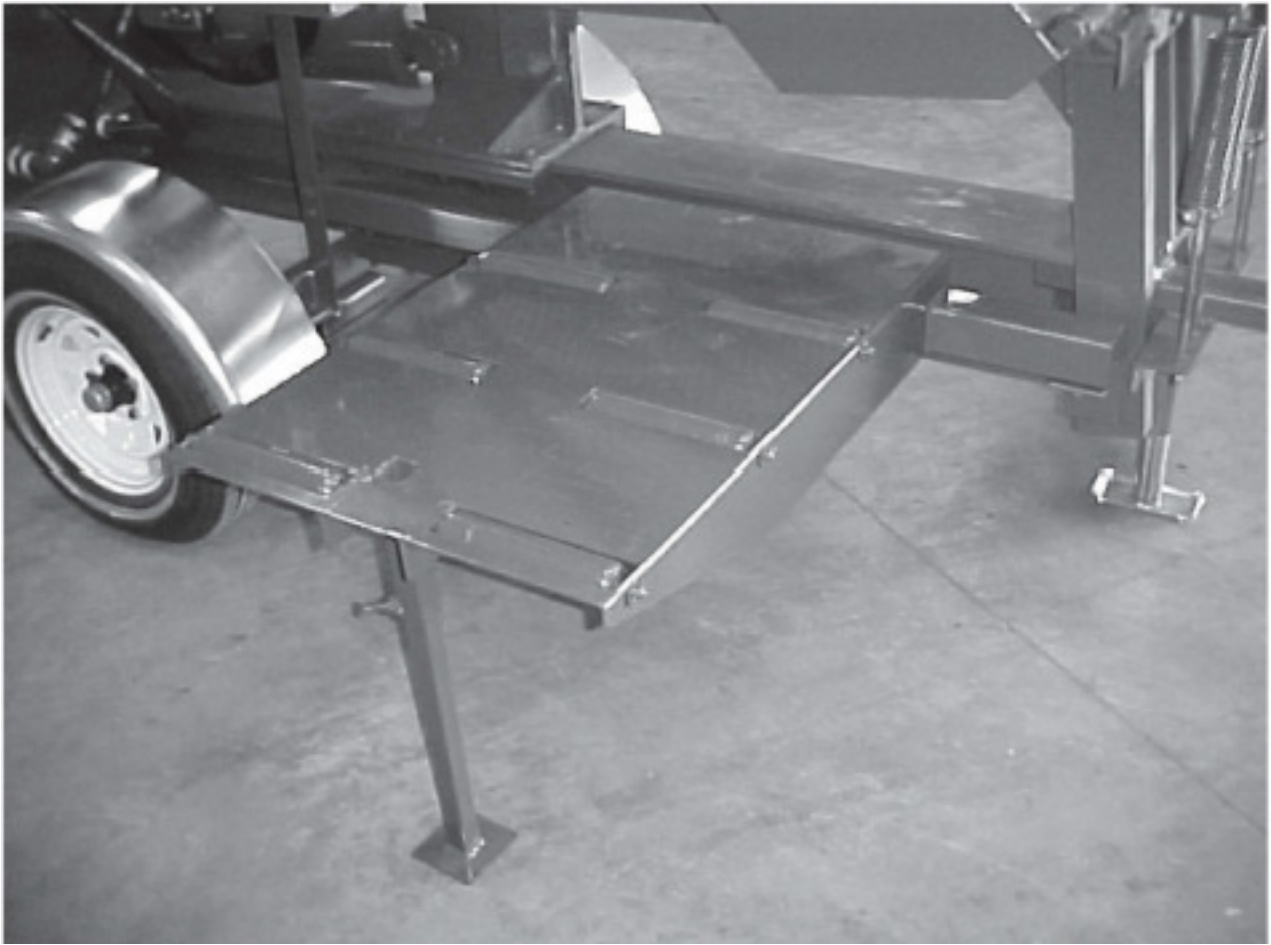

Drawing



TIRE SERVICE INTERNATIONAL

PHOENIX, AZ - MONTICELLO, MN 1-800-223-4540

TC-300
WHEEL CRUSHER

PN 6174

MAIN ASSEMBLY REPAIR BOM

BEGINNING SERIAL NO.1585

02-09-09

PN	POWER PLANT
6175	BRIGGS
6177	ELECTRIC
6178	DIESEL

PN 6174 USED WITH ABOVE POWER PLANTS

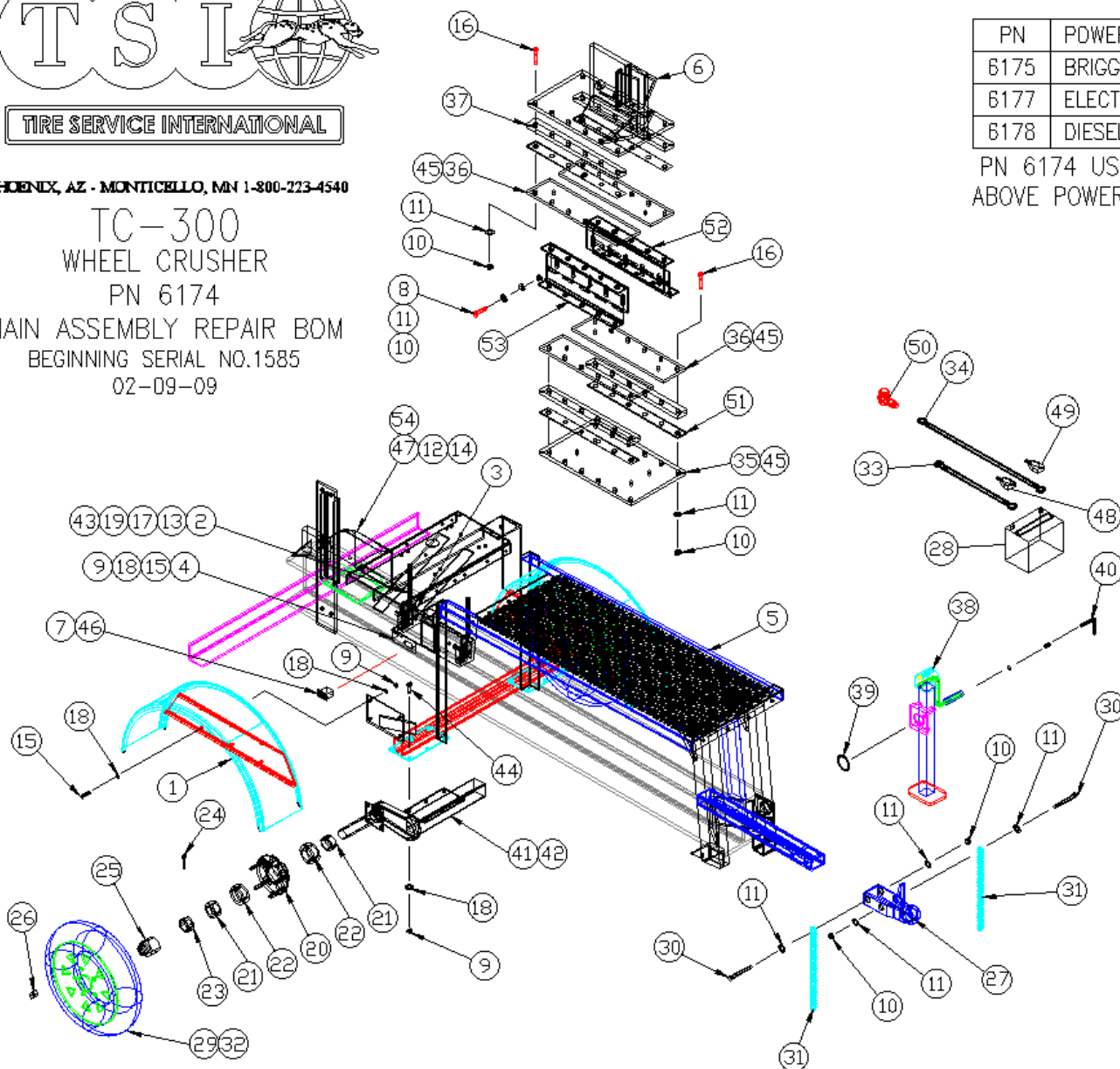

Parts List

PARTS LIST

ITEM	PART N.	DESCRIPTION	QTY
1	5519	FENDER WELDMENT RH & LH	2
2	5534	HANDLE WELD	2
3	5535-01	PIVOT WELD	1
4	5578	VALVE MOUNT WELD	1
5	5600	MAIN FRAME WELD ASSEMBLY	1
6	5602	VERTICAL PUSHER ASSEMBLY	1
7	365.028	MACH SCREW 10-32 X 3/8	2
8	206	HHCS 1/2-13 X 1-1/2 GRD	8
9	212	NUT 3/8-16 HEX NYLOK	22
10	223	NUT 1/2-13 SELF LOCK	36
11	224	WASHER 1/2 FLAT	48
12	226	NUT 1/4-20 SELF LOCK	2
13	230	GRIP, PLASTIC 1/2 X 3-1/2	2
14	445	WASHER 1/4 FLAT WROUGHT	2
15	447	HHCS 3/8-16 X 1-1/4	10
16	485	HHCS 1/2-13 X 2-3/4	24
17	566	NUT 5/16 HEX NYLOK	2
18	700	WASHER 3/8 FLAT	44
19	1318	WASHER 5/16 FLAT	4
20	3025-1	HUB, WHEEL	2
21	3025-2	SEAL, BEARING	4
22	3025-3	BEARING, TAPERED	4
23	3025-4	NUT, SPINDLE	2
24	3025-5	COTTER PIN	2
25	3025-6	WHEEL HUB	2
26	3025-7	WHEEL LUG	10
27	3027	TRAILER COUPLER 3500#	2
28	3033	BATTERY 12 VOLT	1
29	3034	WHEEL 13" 5-HOLE	2
30	3080	HHCS 1/2-13 X 4-1/2	2 60

PARTS LIST

ITEM	PART NO.	DESCRIPTION	QTY
31	3081	SAFETY CHAIN W/HOOK	2
32	3084	TIRE, 185 X 13 2 PLY	2
33	3162	BATTERY CABLE 16" (POS)	1
34	3163	BATTERY CABLE 26" (NEG)	1
35	3323	SLIDE PLATE	1
36	3324	LOWER SLIDE	4
37	3325	SPACER SLIDE	4
10	38	3330 JACK 10" LIFT 2000#	1
39	3330-1	SNAP RING	1
40	3330-2	PIN AND SPRING	1
41	3397	SPINDLE AXLE - RH	1
42	3398	SPINDLE AXLE - LH	1
43	3478	HHCS 5/16 X 1-1/4	2
44	3500	HHCS 3/8-16 X 1-1/2	12
45	3501	FITTING 1/8 NPT STRAIGHT ZERK	12
46	4426	HOUR METER	1
47	10197B	BATTERY COVER	1
48	10407	BATTERY POST GUARD, RED-POS	1
49	10408	BATTERY POST GUARD, BLACK-NEG	1
50	10664	RING BOOT, STARTER END	1
51	10934	SLIDE SPACER	4
52	11578	PLATE, SLIDER ADJUSTMENT TOP	2
53	11579	PLATE, SLIDER ADJUSTMENT BOTTOM	2
54	3155	RUBBER STRAP 10"	1
55			
56			
57			
58			
59			

California Proposition 65

California's Proposition 65 entitles California consumers to special warnings for products that contain chemicals known to the state of California to cause cancer and birth defects or other reproductive harm if those products expose consumers to such chemicals above certain threshold levels.

WARNING: Some of Tire Service International's products can expose you to chemicals including chromium compounds, which are known to the State of California to cause cancer, birth defects or other reproductive harm. For more information, go to www.P65Warnings.ca.gov.

Your risk from exposure to these chemicals varies, depending on exposure time. To reduce your exposure, work in a well-ventilated area and with approved safety equipment, such as dust masks that are specially designed to filter out microscopic particles. Wash your hands after touching TSI's products.

Warranty and Return Policy

Warranty & Workmanship you can depend on.

With over 30 years of manufacturing experience we maintain the ability to provide competitive prices while employing and manufacturing the majority of our products in the USA. Pride in our workmanship and standing behind each and every product is not just our claim but our uncompromising responsibility.

Tire Service International equipment is warranted to be free from defects in materials and workmanship for a period of one year from the date of original purchase to the original owner. Repair labor is warranted for 90 days from the date of original purchase. Bushings, blades, bearings and normal wear and tear are not covered under warranty. Careless handling, negligence, misuse, abuse, mutilation, improper operation, making unauthorized repairs, additions, and or alterations automatically cancel this warranty and relieves TSI of any obligation. Cheetah tanks claimed to be defective while under warranty will be evaluated at our manufacturing plant and either repaired if possible or exchanged and returned or credit issued to the customer account at our discretion. Damage resulting from dropping the tanks will not receive warranty consideration. Warranty parts need to be returned prepaid to the plant for credit. Any replacement parts shipped from the plant will be shipped at the customer's expense. Machines requiring warranty work must be brought to the manufacturing plant in 201 Chelsea Rd, Monticello, MN or to a repair facility authorized by TSI.

!!WARNING!! Goods returned without an RGA will be refused. A Returned Goods Authorization form must be obtained before returning any material or goods. All non-warranty returns will be subject to a 15% restocking fee plus any additional charges for reconditioning/repacking.

Visit www.buyTSI.com for any additional information. Also be sure to follow us on all the Socials, and subscribe to our YouTube channel for all our product videos.

No part of this manual may be reproduced without specific approval from
Tire Service International, LLC.

Copyright © 2024 Tire Service International, LLC

